

DELPHI SERIES



FEATURES

- Efficiency up to 83%
- Industry standard form factor and pinout
- Size:
31.8 x20.3 x10.7mm (1.25" x0.80" x0.42")
- Input: 24V, 48V, 110V (4:1)
- Output: 5, 12, ± 12 , ± 15 V
- Low ripple and noise
- Short circuit protection
- 4200 Vdc isolation
- Meets UL60950-1 / EN55022 Class B
- ISO 9001 and ISO14001 certified manufacturing facility

Delphi DIHW2000 Series DC/DC Power Modules: 24, 48, 110Vin, 3W DIP 4200Vdc isolation, single/dual output

The Delphi DIHW2000, 24, 48, 110V input, single or dual output, DIP form factor, isolated DC/DC converter is the latest offering from a world leader in power systems technology and manufacturing — Delta Electronics, Inc. The DIHW2000 series operate from 24V, 48V, or 110V (4:1) and provides 5V or 12V of single output and ± 12 V or ± 15 V of dual output in an industrial standard, plastic case encapsulated DIP package. This series provides up to 3W of output power with 4200Vdc isolation and a typical full-load efficiency up to 84%. With creative design technology and optimization of component placement, these converters possess outstanding electrical and thermal performance, as well as extremely high reliability under highly stressful operating conditions.

OPTIONS

APPLICATIONS

- Industrial
- Transportation
- Process/ Automation

TECHNICAL SPECIFICATIONS

T_A = 25°C, airflow rate = 0 LFM, nominal Vin, nominal Vout, resistive load unless otherwise noted.

PARAMETER	NOTES and CONDITIONS	DIHW2000 (Standard)			
		Min.	Typ.	Max.	Units
ABSOLUTE MAXIMUM RATINGS					
Input Voltage					
Transient	24VDC input model, 1000ms	-0.7		50	Vdc
Transient	48VDC input model, 1000ms	-0.7		100	Vdc
Transient	110VDC input model, 1000ms	-0.7		180	Vdc
Internal Power Dissipation				2500	mW
Operating Temperature	Ambient	-40		85	°C
	Case	-40		100	°C
Storage Temperature		-40		125	°C
Humidity				95	%
Lead Temperature in Assembly	1.5mm from case for 10 seconds			260	°C
Input/Output Isolation Voltage		5600			Vdc
INPUT CHARACTERISTICS					
Operating Input Voltage	24V model	9	24	40	Vdc
	48V model	18	48	80	
	110V model	36	110	160	Vdc
Turn-On Voltage Threshold	24V model	8	8.5	9	Vdc
	48V model	13	15	17	Vdc
	110V model	26	30	34	Vdc
Turn-Off Voltage Threshold	24V model	---	---	8.5	Vdc
	48V model	---	---	16	Vdc
	110V model	---	---	32	Vdc
Maximum Input Current	Please see Model List table on page 6				
No-Load Input Current	24V model		20		mA
	48V model		10		mA
	110V model		5		mA
Input Reflected Ripple Current	24V model			15	%
	48V model			8	%
	110V model			3	%
Short Circuit Input Power	All models			2	W
Reverse Polarity Input Current				0.3	A
OUTPUT CHARACTERISTICS					
Output Voltage Set Point Accuracy			±0.5	±1.0	%
Output Voltage Balance	Dual output models, balanced loads		±0.5	±2.0	%
Output Voltage Regulation					
Over Load	I _o =25% to 100%		±0.5	±1.0	%
Over Line	V _{in} = min to max		±0.3	±0.5	%
Over Temperature	T _c =-40°C to 100°C		±0.02	±0.05	%/C
Output Voltage Ripple and Noise	5Hz to 20MHz bandwidth				
Peak-to-Peak	5V output, Full Load, 0.33µF ceramic		75	100	mVp-p
Peak-to-Peak	Other outputs, Full Load, 0.33µF ceramic		100	150	mVp-p
Peak-to-Peak, over line, load, temperature	Full Load, 0.33µF ceramic			180	mVp-p
RMS	Full Load, 0.33µF ceramic			15	mVrms
Output Over Current/Power Protection	Auto restart	120			%
Output Short Circuit	Continuous				
Output Voltage Current Transient					
Step Change in Output Current	25% step change		±3	±6	%
Settling Time (within 1% Vout nominal)			150	500	µS
Maximum Output Capacitance	5V output			1000	µF
	12V output			470	µF
	Dual output models, each output			220	µF
EFFICIENCY					
100% Load	Please see Model List table on page 6				
ISOLATION CHARACTERISTICS					
Isolation Voltage	Input to output, 60 Seconds	4200			Vdc
Isolation Voltage Test	Flash Test for 1 seconds	5000			Vdc
Leakage Current	240VAC, 60Hz			2	µA
Isolation Resistance	500VDC	1000			MΩ
Isolation Capacitance	100KHz, 1V		7	13	pF
FEATURE CHARACTERISTICS					
Switching Frequency			150		kHz
GENERAL SPECIFICATIONS					
MTBF	MIL-HDBK-217F; Ta=25°C, Ground Benign	1			M hours
Weight			16.2		grams
Case Material	Non-conductive black plastic				
Flammability	UL94V-0				
Input Fuse	24V model, 1000mA slow blown type				
	48V model, 500mA slow blown type				
	110V model, 300mA slow blown type				

Notes:

- These power converters require a minimum output load to maintain specified regulation (please see page 7 for the suggested minimum load). Operation under no-load conditions will not damage these modules; however, they may not meet all specifications listed above.
- These DC/DC converters should be externally fused at the front end for protection.



ELECTRICAL CHARACTERISTICS CURVES

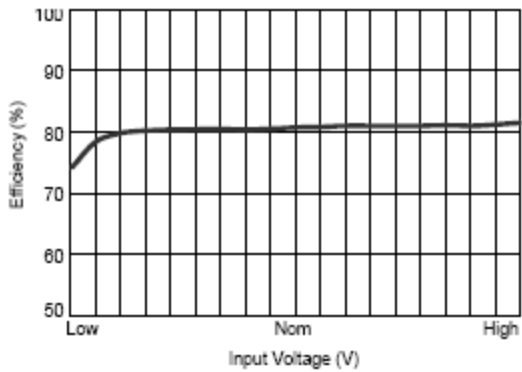

Figure 1: Efficiency vs. Input Voltage (Single Output)

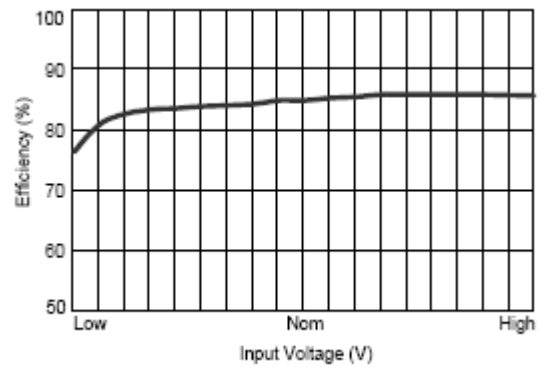

Figure 2: Efficiency vs. Input Voltage (Dual Output)

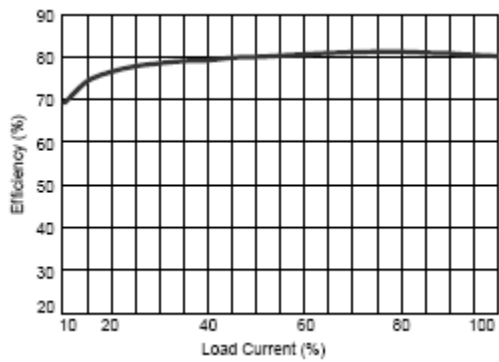

Figure 3: Efficiency vs. Output Load (Single Output)

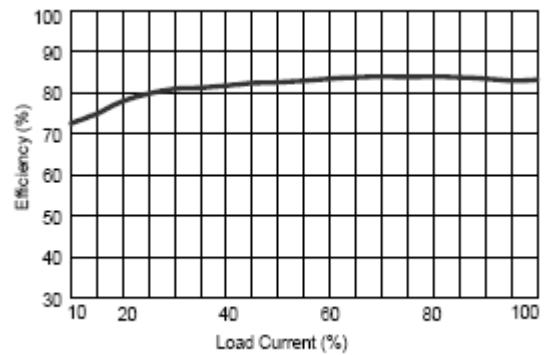

Figure 4: Efficiency vs. Output Load (Dual Output)

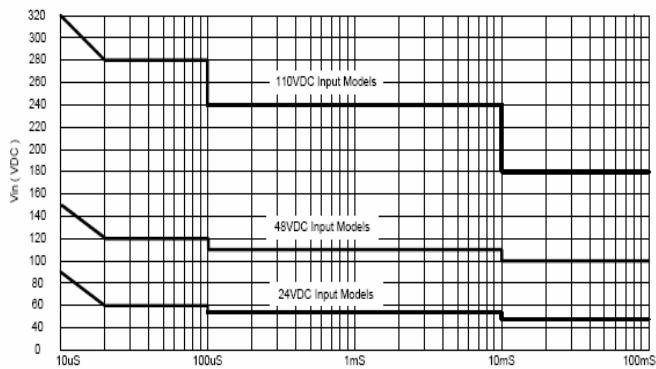
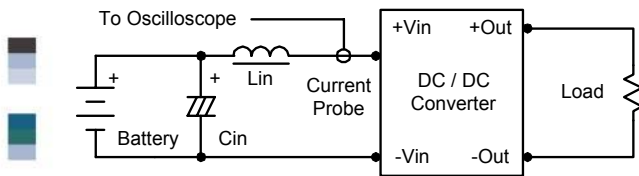

Figure 5: Input Voltage Transient Rating



Test Configurations



Input Reflected-Ripple Current Test Setup

Input reflected-ripple current is measured with an inductor L_{in} ($4.7\mu\text{H}$) and C_{in} ($220\mu\text{F}$, $\text{ESR} < 1.0\Omega$ at 100 KHz) to simulate source impedance. Capacitor C_{in} is to offset possible battery impedance. Current ripple is measured at the input terminals of the module and measurement bandwidth is $0\text{-}500\text{ KHz}$.

Peak-to-Peak Output Noise Measurement

Scope measurement should be made by using a BNC socket, measurement bandwidth is $0\text{-}20\text{ MHz}$. Position the load between 50 mm and 75 mm from the DC/DC Converter. A C_{out} of $0.47\mu\text{F}$ ceramic capacitor is placed between the terminals shown below.

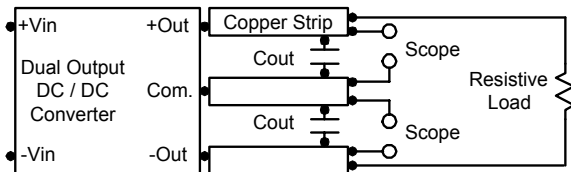
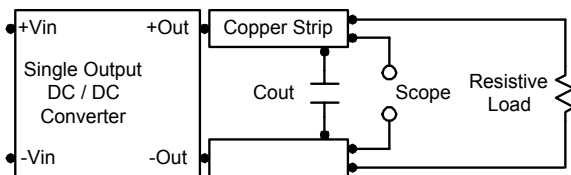

Design & Feature Considerations

The DIHW2000 circuit block diagrams are shown in Figures 6 and 7.

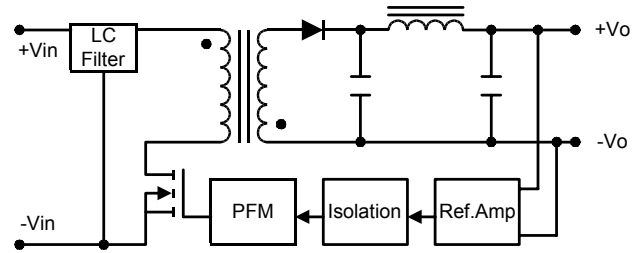

Figure 6: Block diagram of DIHW2000 single output modules.

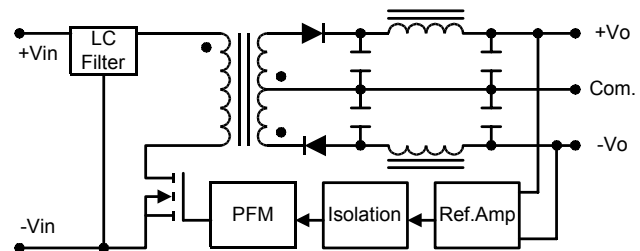
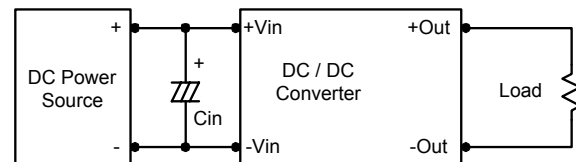

Figure 7: Block diagram of DIHW2000 dual output modules

Input Source Impedance

The power module should be connected to a low ac-impedance input source. Highly inductive source impedances can affect the stability of the power module.



In applications where power is supplied over long lines and output loading is high, it may be necessary to use a capacitor at the input to ensure startup.

Capacitor mounted close to the input of the power module helps ensure stability of the unit, it is recommended to use a good quality low Equivalent Series Resistance ($\text{ESR} < 1.0\Omega$ at 100 KHz) capacitor of a $4.7\mu\text{F}$ for the 24V and a $2.2\mu\text{F}$ for the 48V devices.

Design & Feature Considerations

Maximum Capacitive Load

The DIHW2000 series has limitation of maximum connected capacitance at the output. The power module may be operated in current limiting mode during start-up, affecting the ramp-up and the startup time. The maximum capacitance can be found on page 2 of this datasheet.

Output Ripple Reduction

A good quality low ESR capacitor placed as close as practicable across the load will give the best ripple and noise performance.

To reduce output ripple, it is recommended to use 3.3 μ F capacitors at the output.

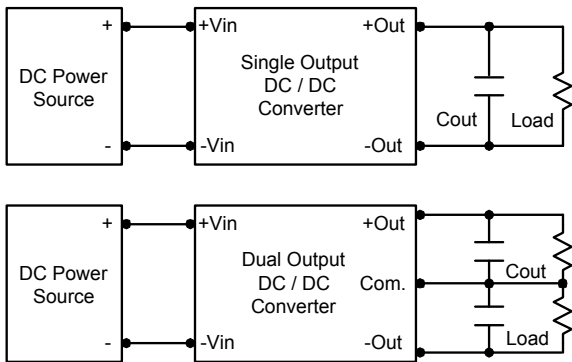

Overcurrent Protection

To provide protection in a fault (output overload) condition, the unit is equipped with internal current limiting circuitry and can endure current limiting for an unlimited duration. At the point of current-limit inception, the unit shifts from voltage control to current control. The unit operates normally once the output current is brought back into its specified range.

Soldering and Cleaning Considerations

Post solder cleaning is usually the final board assembly process before the board or system undergoes electrical testing. Inadequate cleaning and/or drying may lower the reliability of a power module and severely affect the finished circuit board assembly test. Adequate cleaning and/or drying is especially important for un-encapsulated and/or open frame type power modules. For assistance on appropriate soldering and cleaning procedures, please contact Delta's technical support team.

Notes:

1. These power converters require a minimum output load to maintain specified regulation (please see page 2 for the suggested minimum load). Operation under no-load conditions will not damage these modules; however, they may not meet all specifications listed above.
2. These DC/DC converters should be externally fused at the front end for protection.



THERMAL CONSIDERATIONS

Thermal management is an important part of the system design. To ensure proper, reliable operation, sufficient cooling of the power module is needed over the entire temperature range of the module. Convection cooling is usually the dominant mode of heat transfer.

Hence, the choice of equipment to characterize the thermal performance of the power module is a wind tunnel.

Thermal Testing Setup

Delta's DC/DC power modules are characterized in heated vertical wind tunnels that simulate the thermal environments encountered in most electronics equipment. This type of equipment commonly uses vertically mounted circuit cards in cabinet racks in which the power modules are mounted.

The following figure shows the wind tunnel characterization setup. The power module is mounted on a test PWB and is vertically positioned within the wind tunnel. The space between the facing PWB and PWB is constantly kept at 25.4mm (1").

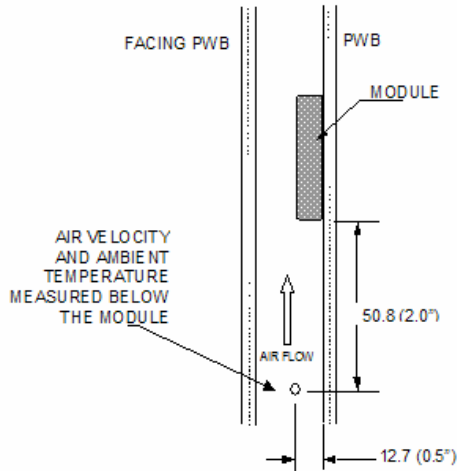

Note: Wind Tunnel Test Setup Figure Dimensions are in millimeters and (Inches)

Figure 7: Wind tunnel test setup

Thermal Derating

Heat can be removed by increasing airflow over the module. To enhance system reliability, the power module should always be operated below the maximum operating temperature. If the temperature exceeds the maximum module temperature, reliability of the unit may be affected.

THERMAL CURVES

DIHW2000series Output Current vs. Ambient Temperature and Air Velocity (Either Orientation)

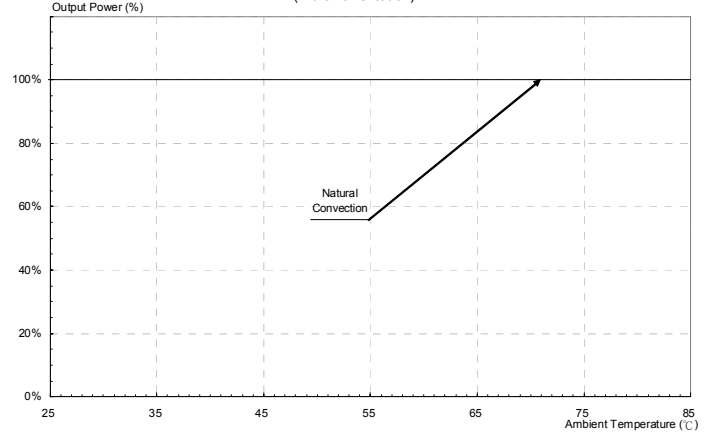

Figure 8: Derating Curve



MODEL LIST

MODEL NAME	INPUT		OUTPUT			Full Load Efficiency %
	Vdc (V)	Max (mA)	Vdc (V)	Max (mA)	Min (mA)	
DIHW2022	24 (9 ~ 40)	160	5	600	90	78
DIHW2023		151	12	250	37.5	83
DIHW2026		151	±12	±125	±18.8	83
DIHW2027		151	±15	±100	±15	83
DIHW2032	48 (18 ~ 80)	80	5	600	90	78
DIHW2033		75	12	250	37.5	83
DIHW2036		75	±12	±125	±18.8	83
DIHW2037		75	±15	±100	±15	83
DIHW2042	110 (36 ~ 160)	35	5	600	90	78
DIHW2043		33	12	250	37.5	83
DIHW2046		33	±12	±125	±18.8	83
DIHW2047		33	±15	±100	±15	83

MECHANICAL DRAWING

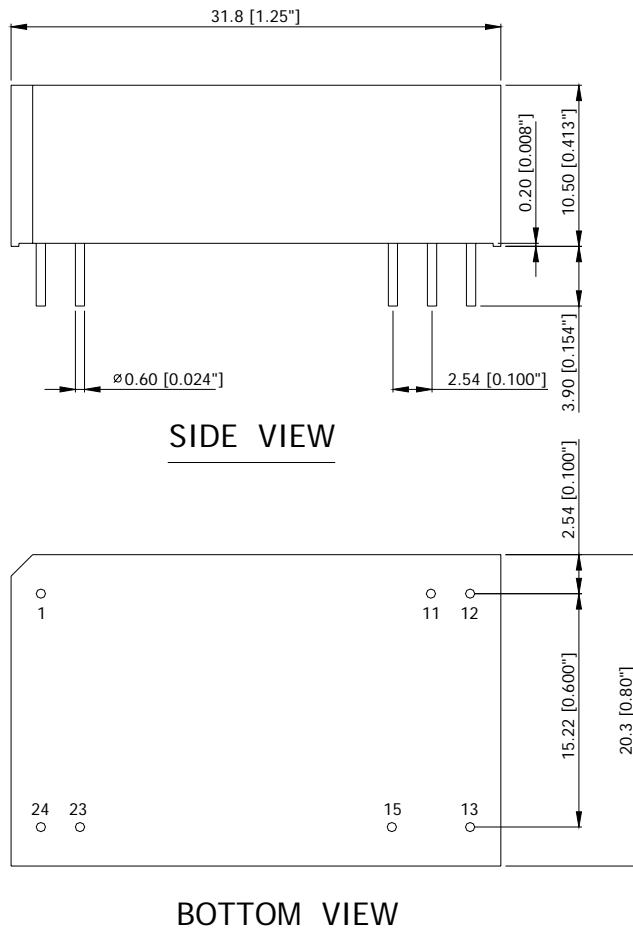

Pin	Single Output	Dual Output
1	+Vin	+Vin
11	NC	Common
12	-Vout	NC
13	+Vout	-Vout
15	NC	+Vout
23	-Vin	-Vin
24	-Vin	-Vin

NOTES:
 DIMENSIONS ARE IN MILLIMETERS AND (INCHES)
 TOLERANCES: X.Xmm \pm 0.5mm(X.XX in. \pm 0.02 in.)
 X.XXmm \pm 0.25mm(X.XXX in. \pm 0.010 in.)

CONTACT: www.delta.com.tw/dc dc

USA:

Telephone:
 East Coast: (888) 335 8201
 West Coast: (888) 335 8208
 Fax: (978) 656 3964
 Email: DCDC@delta-corp.com

Europe:

Phone: +41 31 998 53 11
 Fax: +41 31 998 53 53
 Email: DCDC@delta-es.com

Asia & the rest of world:

Telephone: +886 3 4526107 ext 6220~6224
 Fax: +886 3 4513485
 Email: DCDC@delta.com.tw

WARRANTY

Delta offers a two (2) year limited warranty. Complete warranty information is listed on our web site or is available upon request from Delta. Information furnished by Delta is believed to be accurate and reliable. However, no responsibility is assumed by Delta for its use, nor for any infringements of patents or other rights of third parties, which may result from its use. No license is granted by implication or otherwise under any patent or patent rights of Delta. Delta reserves the right to revise these specifications at any time, without notice.